

BR 850 005

→ BR 868 XXX
→ BR 838 XXX
→ BR 852 XXX

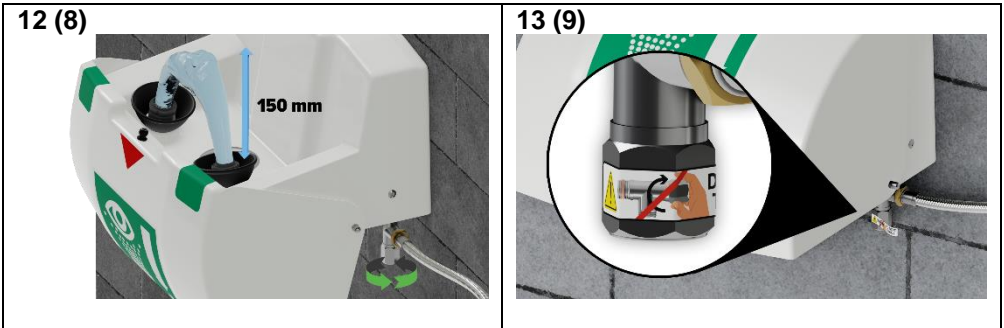



BR 850 005

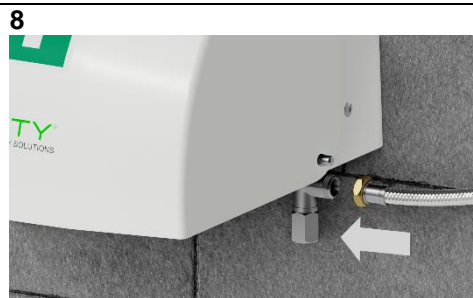
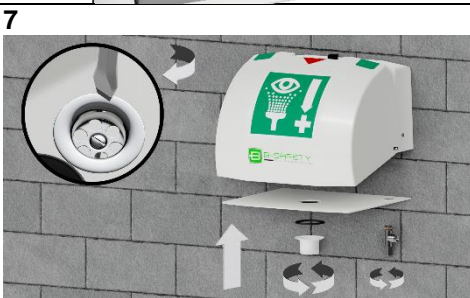
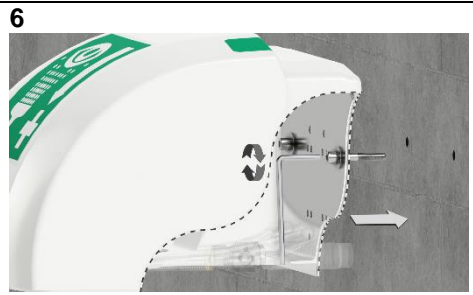
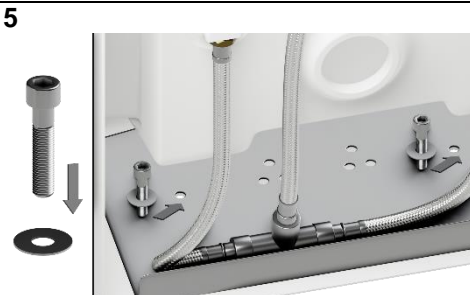
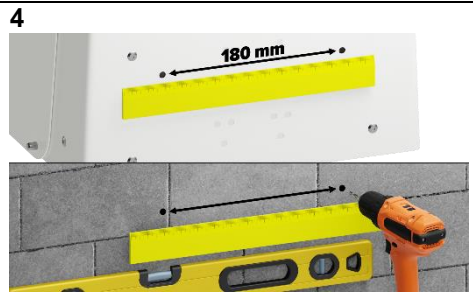
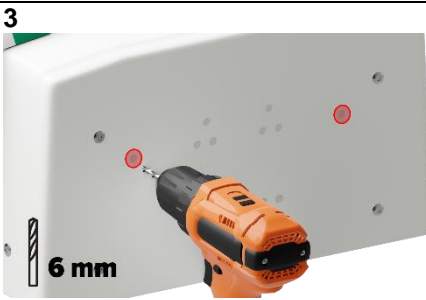



BR 850 005 -> BR 868 XXX

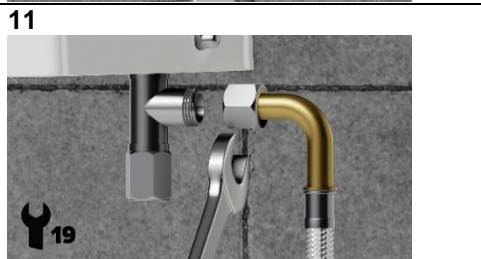
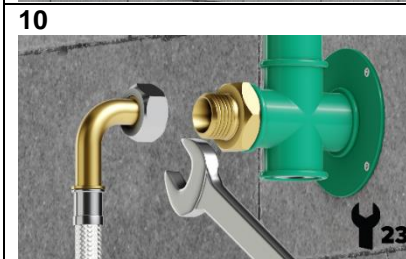
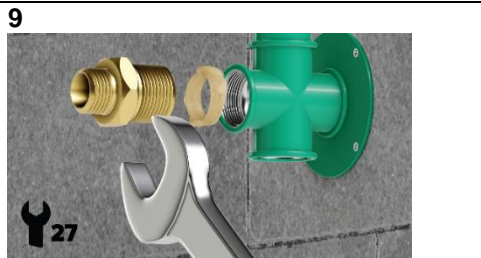
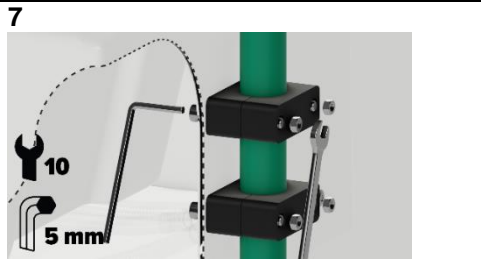
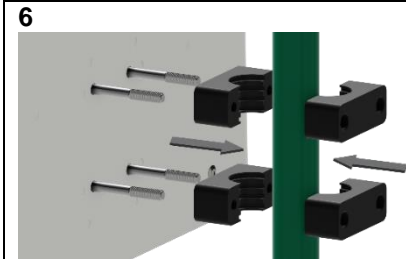



BR 850 005 -> BR 838 XXX
BR 852 XXX

